

Fișă tehnică | Număr articol: 750-430
8-channel digital input; 24 VDC; 3 ms; light gray

www.wago.com/750-430

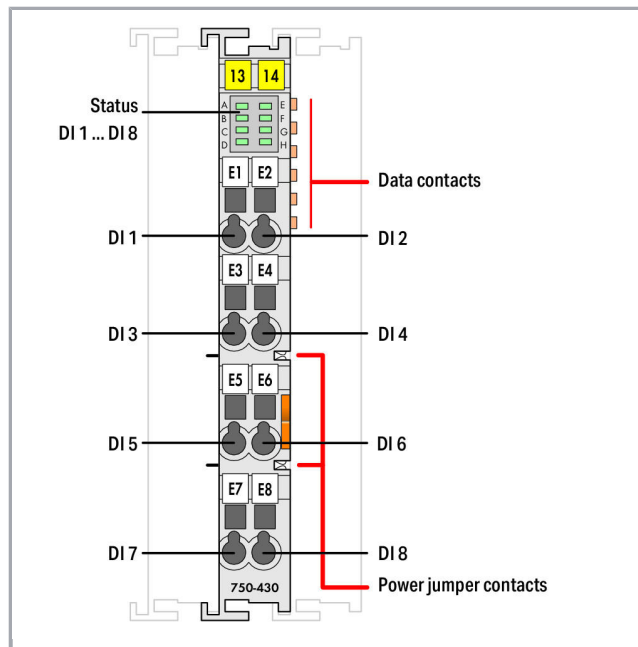

RoHS Compliant

[BOMcheck.net](https://www.bomcheck.net)

Culoare: ■

Supus modificărilor.

WAGO Kontakttechnik GmbH & Co. KG
/Representative Office Romania
Sos. Pipera-Tunari nr. 1/1
building 1, 2nd floor | 077190 Voluntari, Ilfov
Tel.: +40-(0)31 421 85 68 | Email: info-RO@wago.com

Aveți întrebări despre produsele noastre?
Vă stăm la dispoziție pentru preluarea apelului la +40 (0) 31 421 85 68.

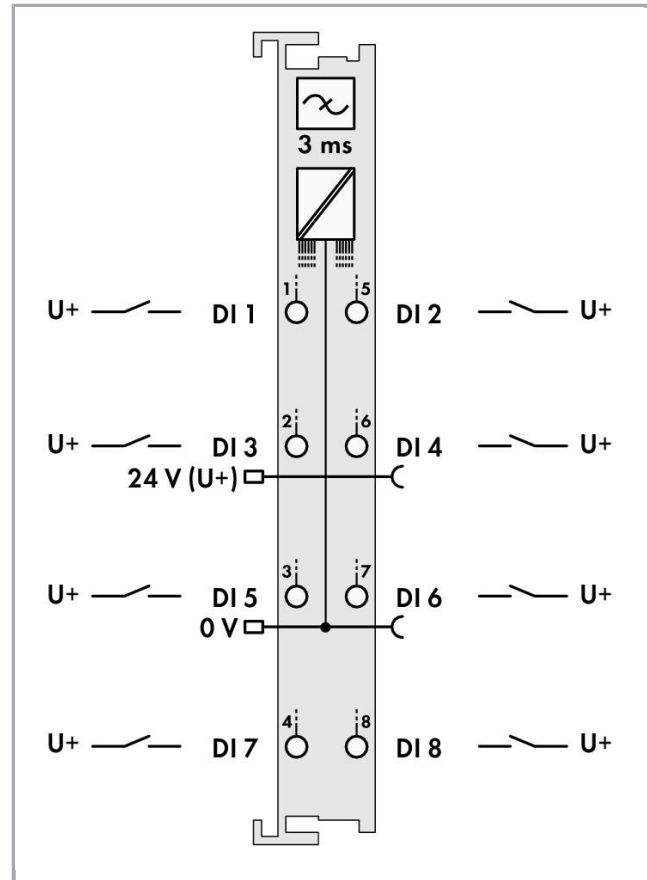
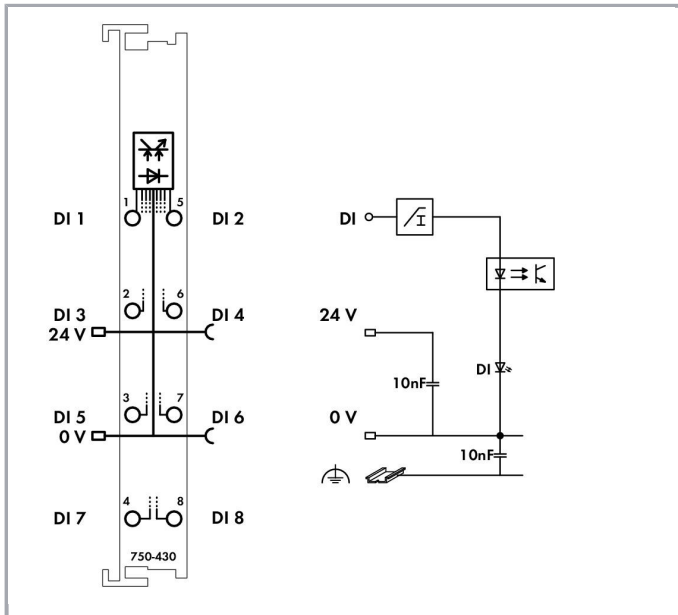

Descriere articol

The digital input module provides 8 channels in a width of just 12 mm (0.47 inch). It receives control signals from digital field devices (e.g., sensors).

Each input module has a noise-rejection filter.

Field and system levels are electrically isolated.

Date

Technical Data

Number of digital inputs	8
Total number of channels (module)	8
Type of signal	Voltage
Type of signal voltage	DC 24 V
Sensor connection	8 x (1-conductor)
Input characteristic	high-side switching
Input filter (digital)	3 ms

Supus modificărilor.

WAGO Kontakttechnik GmbH & Co. KG
 /Representative Office Romania
 Sos. Pipera-Tunari nr. 1/1
 building 1, 2nd floor | 077190 Voluntari, Ilfov
 Tel.: +40-(0)31 421 85 68 | Email: info-RO@wago.com

Aveți întrebări despre produsele noastre?
 Vă stăm la dispoziție pentru preluarea apelului la +40 (0) 31 421 85 68.



Input current per channel for signal (1) typ.	2,8 mA
Voltage range for signal (0)	-3 ... +5 VDC
Voltage range for signal (1)	15 ... 30 VDC
Max input data width (internal)	8 Bit
System supply voltage	DC 5 V; via data contacts
Current consumption, system supply (5 V)	17 mA
Field supply voltage	DC 24 V (-25 ... +30 %); via power jumper contacts (power supply via blade contact; transmission via spring contact)
Isolation	500 V system/supply
Indicators	LED (A-D) green: Status DI 1, DI 3, DI 5, DI 7; LED (E-H) green: Status DI 2, DI 4, DI 6, DI 8
Number of incoming power jumper contacts	2
Number of outgoing power jumper contacts	2
Current carrying capacity of the power jumper contacts	10 A

Connection data

Connection technology: In-/Outputs	8 x CAGE CLAMP®
Connection type (1)	Inputs/Outputs
Solid conductor	0.08 ... 2.5 mm ² / 28 ... 14 AWG
Fine-stranded conductor	0.08 ... 2.5 mm ² / 28 ... 14 AWG
Strip length	8 ... 9 mm / 0.31 ... 0.35 inch

Geometrical Data

Width	12 mm / 0.472 inch
Height	67.8 mm / 2.669 inch
Height from upper-edge of DIN-35 rail	60.6 mm / 2.386 inch
Depth	100 mm / 3.937 inch

Mechanical data

Type of mounting	DIN-35 rail
------------------	-------------

Material Data

Color	light gray
Housing material	Polycarbonate, polyamide 6.6
Weight	47 g
Conformity marking	CE

Supus modificărilor.

WAGO Kontakttechnik GmbH & Co. KG
 /Representative Office Romania
 Sos. Pipera-Tunari nr. 1/1
 building 1, 2nd floor | 077190 Voluntari, Ilfov
 Tel.: +40-(0)31 421 85 68 | Email: info-RO@wago.com

Aveți întrebări despre produsele noastre?
 Vă stăm la dispoziție pentru preluarea apelului la +40 (0) 31 421 85 68.

Environmental Requirements

Surrounding air (operating) temperature	0 ... 55 °C
Surrounding air (storage) temperature	-40 ... 85 °C
Protection class	IP20
Degree of pollution (5)	2 per IEC 61131-2
Operating altitude	0 ... 2000 m
Mounting position	horizontal (standing/lying) or vertical
Relative air humidity (no condensation)	95 %
Vibration resistance	4g per IEC 60068-2-6
Shock resistance	15g per IEC 60068-2-27
EMC immunity to interference	acc. to EN 61000-6-2, marine applications
EMC emission of interference	acc. to EN 61000-6-4, marine applications
Exposure to pollutants	Per IEC 60068-2-42 and IEC 60068-2-43
Permissible H ₂ S contaminant concentration at a relative humidity 75 %	10 ppm
Permissible SO ₂ contaminant concentration at a relative humidity 75 %	25 ppm

Commercial data

Product Group	15 (Remote I/O)
Packaging type	BOX
Country of origin	DE
GTIN	4045454392802
Customs Tariff No.	85389099990

Aprobări / certificate

Ex-Approvals

Emblemă	Aprobare	Text de aprobare suplimentar	Nume certificat
	ATEX TUEV Nord Cert GmbH	EN 60079-0	TÜV 07 ATEX 554086 X en.
	TUEV Nord TUEV Nord Cert GmbH	IEC 60079-0	IECEx TUN 09.0001 X
	UL	UL 121201	E198726

Supus modificărilor.

WAGO Kontakttechnik GmbH & Co. KG
/Representative Office Romania
Sos. Pipera-Tunari nr. 1/1
building 1, 2nd floor | 077190 Voluntari, Ilfov
Tel.: +40-(0)31 421 85 68 | Email: info-RO@wago.com

Aveți întrebări despre produsele noastre?
Vă stăm la dispoziție pentru preluarea apelului la +40 (0) 31 421 85 68.



Underwriters Laboratories Inc. (HAZARDOUS LOCATIONS)

Sec.1

Country specific Approvals

Emblemă	Aprobare	Text de aprobare suplimentar	Nume certificat
	KC National Radio Research Agency	Article 58-2, Clause 3	MSIP-REM-W43-DIM750

Ship Approvals

Emblemă	Aprobare	Text de aprobare suplimentar	Nume certificat
	ABS American Bureau of Shipping	-	19-HG1821926
	BV Bureau Veritas S.A.	-	13453/DO BV
	DNV GL Det Norske Veritas, Germanischer Lloyd	-	TAA0000194
	KR Korean Register of Shipping	-	KR HMB05880-AC001
	LR Lloyds Register	-	02/20026 (E6)
	NK Nippon Kaiji Kyokai	-	TA17255M
	PRS Polski Rejestr Statków	-	TE/2236/880590/19

Supus modificărilor.

WAGO Kontakttechnik GmbH & Co. KG
/Representative Office Romania
Sos. Pipera-Tunari nr. 1/1
building 1, 2nd floor | 077190 Voluntari, Ilfov
Tel.: +40-(0)31 421 85 68 | Email: info-RO@wago.com

Aveți întrebări despre produsele noastre?
Vă stăm la dispoziție pentru preluarea apelului la +40 (0) 31 421 85 68.



RINA
RINA Germany GmbH







ELE066419XG

UL-Approvals

Emblemă	Aprobare	Text de aprobare suplimentar	Nume certificat
	UL UL International Netherlands B.V. (ORDINARY LOCATIONS)	UL 508	E175199 Sec.1

Produse compatibile















Marking accessories

	Nr. articol: 2009-145 Mini-WSB Inline; for Smart Printer; on reel; stretchable 5 - 5.2 mm; plain; snap-on type; white	www.wago.com/2009-145
	Nr. articol: 2009-145/000-002 Mini-WSB Inline; for Smart Printer; on reel; stretchable 5 - 5.2 mm; plain; snap-on type; yellow	www.wago.com/2009-145/000-002
	Nr. articol: 2009-145/000-005 Mini-WSB Inline; for Smart Printer; on reel; stretchable 5 - 5.2 mm; plain; snap-on type; red	www.wago.com/2009-145/000-005
	Nr. articol: 2009-145/000-006 Mini-WSB Inline; for Smart Printer; on reel; stretchable 5 - 5.2 mm; plain; snap-on type; blue	www.wago.com/2009-145/000-006
	Nr. articol: 2009-145/000-007 Mini-WSB Inline; for Smart Printer; on reel; stretchable 5 - 5.2 mm; plain; snap-on type; gray	www.wago.com/2009-145/000-007
	Nr. articol: 2009-145/000-012 Mini-WSB Inline; for Smart Printer; on reel; stretchable 5 - 5.2 mm; plain; snap-on type; orange	www.wago.com/2009-145/000-012
	Nr. articol: 2009-145/000-023 Mini-WSB Inline; for Smart Printer; on reel; stretchable 5 - 5.2 mm; plain; snap-on type; green	www.wago.com/2009-145/000-023

Supus modificărilor.

WAGO Kontakttechnik GmbH & Co. KG
/Representative Office Romania
Sos. Pipera-Tunari nr. 1/1
building 1, 2nd floor | 077190 Voluntari, Ilfov
Tel.: +40-(0)31 421 85 68 | Email: info-RO@wago.com

Aveți întrebări despre produsele noastre?
Vă stăm la dispoziție pentru preluarea apelului la +40 (0) 31 421 85 68.

	Nr. articol: 2009-145/000-024 Mini-WSB Inline; for Smart Printer; on reel; stretchable 5 - 5.2 mm; plain; snap-on type; violet	www.wago.com/2009-145/000-024
	Nr. articol: 248-501 Miniature WSB Quick marking system; plain; Marker width 5 mm; 10 strips with 10 markers per card	www.wago.com/248-501
	Nr. articol: 248-501/000-002 Mini-WSB marking card; as card; not stretchable; plain; snap-on type; yellow	www.wago.com/248-501/000-002
	Nr. articol: 248-501/000-005 Mini-WSB marking card; as card; not stretchable; plain; snap-on type; red	www.wago.com/248-501/000-005
	Nr. articol: 248-501/000-006 Mini-WSB marking card; as card; not stretchable; plain; snap-on type; blue	www.wago.com/248-501/000-006
	Nr. articol: 248-501/000-007 Mini-WSB marking card; as card; not stretchable; plain; snap-on type; gray	www.wago.com/248-501/000-007
	Nr. articol: 248-501/000-012 Mini-WSB marking card; as card; not stretchable; plain; snap-on type; orange	www.wago.com/248-501/000-012
	Nr. articol: 248-501/000-017 Mini-WSB marking card; as card; not stretchable; plain; snap-on type; light green	www.wago.com/248-501/000-017
	Nr. articol: 248-501/000-023 Mini-WSB marking card; as card; not stretchable; plain; snap-on type; green	www.wago.com/248-501/000-023
	Nr. articol: 248-501/000-024 Mini-WSB marking card; as card; not stretchable; plain; snap-on type; violet	www.wago.com/248-501/000-024
	Nr. articol: 750-103 Group marker carrier	www.wago.com/750-103
	Nr. articol: 750-107 Group marker carrier	www.wago.com/750-107
Supply module		
	Nr. articol: 750-601 Power Supply; 24 VDC; fuse holder; light gray	www.wago.com/750-601
	Nr. articol: 750-602 Power Supply; 24 VDC; light gray	www.wago.com/750-602
	Nr. articol: 750-610 Power Supply; 24 VDC; fuse holder; Diagnostics	www.wago.com/750-610

Supus modificărilor.

**Nr. articol: 750-612**

Power Supply; 0 ... 230 V AC/DC; light gray

www.wago.com/750-612**Carrier rail****Nr. articol: 210-112**

Steel carrier rail; 35 x 7.5 mm; 1 mm thick; 2 m long; slotted; according to EN 60715; "Hole width 25 mm

www.wago.com/210-112**Nr. articol: 210-113**

Steel carrier rail; 35 x 7.5 mm; 1 mm thick; 2 m long; unslotted; according to EN 60715

www.wago.com/210-113**Nr. articol: 210-114**

Steel carrier rail; 35 x 15 mm; 1.5 mm thick; 2 m long; unslotted; similar to EN 60715

www.wago.com/210-114**Nr. articol: 210-115**

Steel carrier rail; 35 x 7.5 mm; 1 mm thick; 2 m long; slotted; according to EN 60715; "Hole width 18 mm

www.wago.com/210-115**Nr. articol: 210-118**

Steel carrier rail; 35 x 15 mm; 2.3 mm thick; 2 m long; unslotted; according to EN 60715

www.wago.com/210-118**Nr. articol: 210-196**

Aluminum carrier rail; 35 x 8.2 mm; 1.6 mm thick; 2 m long; unslotted; similar to EN 60715; silver-colored

www.wago.com/210-196**Nr. articol: 210-197**

Steel carrier rail; 35 x 15 mm; 1.5 mm thick; 2 m long; slotted; similar to EN 60715

www.wago.com/210-197**Nr. articol: 210-198**

Copper carrier rail; 35 x 15 mm; 2.3 mm thick; 2 m long; unslotted; according to EN 60715; copper-colored

www.wago.com/210-198**Nr. articol: 210-504**

Steel carrier rail; 35 x 7.5 mm; 1 mm thick; 2 m long; slotted; galvanized; according to EN 60715

www.wago.com/210-504**Nr. articol: 210-505**

Steel carrier rail; 35 x 7.5 mm; 1 mm thick; 2 m long; unslotted; galvanized; according to EN 60715

www.wago.com/210-505**Nr. articol: 210-506**

Steel carrier rail; 35 x 15 mm; 1.5 mm thick; 2 m long; unslotted; galvanized; similar to EN 60715

www.wago.com/210-506**Nr. articol: 210-508**

Steel carrier rail; 35 x 15 mm; 1.5 mm thick; 2 m long; slotted; galvanized; similar to EN 60715

www.wago.com/210-508**shield connection****Nr. articol: 790-108**

Shield clamping saddle; 11 mm wide; diameter of compatible conductor; 3 ... 8 mm

www.wago.com/790-108**Nr. articol: 790-116**

Shield clamping saddle; 19 mm wide; diameter of compatible conductor; 7 ... 16 mm

www.wago.com/790-116**Nr. articol: 790-124**

Shield clamping saddle; 27 mm wide; diameter of compatible conductor; 6 ... 24 mm

www.wago.com/790-124**Nr. articol: 790-140**

Shield clamping saddle; diameter of compatible conductor

www.wago.com/790-140

Supus modificărilor.

WAGO Kontakttechnik GmbH & Co. KG

/Representative Office Romania















Sos. Pipera-Tunari nr. 1/1

building 1, 2nd floor | 077190 Voluntari, Ilfov

Tel.: +40-(0)31 421 85 68 | Email: info-RO@wago.com

Aveți întrebări despre produsele noastre?

Vă stăm la dispoziție pentru preluarea apelului la +40 (0) 31 421 85 68.

	Nr. articol: 790-208 Shield clamping saddle; 12.4 mm wide; 3 ... 8 mm	www.wago.com/790-208
	Nr. articol: 790-216 Shield clamping saddle; 21.8 mm wide; 6 ... 16 mm	www.wago.com/790-216
	Nr. articol: 790-220 Shield clamping saddle; 30 mm wide; 6 ... 20 mm	www.wago.com/790-220
system box		
	Nr. articol: 850-804 IP65 enclosure; Stainless steel; WxHxD (400x123x200 mm); 4 x M20, 16 x M16, 28 x M12 cable grip	www.wago.com/850-804
	Nr. articol: 850-804/000-001 IP65 enclosure; Stainless steel; WxHxD (400x123x200 mm); 2 x M20, 13 x M16, 32 x M12 cable grip	www.wago.com/850-804/000-001
	Nr. articol: 850-805 IP65 enclosure; Stainless steel; WxHxD (600x123x200 mm); 4 x M20, 19 x M16, 67 x M12 cable grip	www.wago.com/850-805
	Nr. articol: 850-814/002-000 IP65 enclosure; Sheet steel (RAL 7035); WxHxD (200x120x200 mm); without flange plate	www.wago.com/850-814/002-000
	Nr. articol: 850-815/002-000 IP65 enclosure; Sheet steel (RAL 7035); WxHxD (300x120x200 mm); without flange plate	www.wago.com/850-815/002-000
	Nr. articol: 850-816/002-000 IP65 enclosure; Sheet steel (RAL 7035); WxHxD (400x120x200 mm); without flange plate	www.wago.com/850-816/002-000
	Nr. articol: 850-817/002-000 IP65 enclosure; Sheet steel (RAL 7035); WxHxD (600x120x200 mm); without flange plate	www.wago.com/850-817/002-000
	Nr. articol: 850-825 IP65 enclosure; Aluminium (RAL 7032); WxHxD (160x100x160 mm); 9 x M12, 4 x M20	www.wago.com/850-825
	Nr. articol: 850-826 IP65 enclosure; Aluminium (RAL 7032); WxHxD (240x100x160 mm); 4 x M20, 4 x M16, 14 x M12 cable grip	www.wago.com/850-826
	Nr. articol: 850-826/002-000 IP65 enclosure; Aluminium (RAL 7035); WxHxD (240x100x160 mm); 4 x M20, 4 x M16, 14 x M12 cable grip	www.wago.com/850-826/002-000
	Nr. articol: 850-827 IP65 enclosure; Aluminium (RAL 7032); WxHxD (320x100x160 mm); 4 x M20, 8 x M16, 17 x M12 cable grip	www.wago.com/850-827
	Nr. articol: 850-827/002-000 IP65 enclosure; Aluminium (RAL 7035); WxHxD (320x100x160 mm); 4 x M20, 8 x M16, 17 x M12 cable grip	www.wago.com/850-827/002-000

Supus modificărilor.

**Nr. articol: 850-828**

IP65 enclosure; Aluminium (RAL 7032); WxHxD (480x100x160 mm); 4 x M20, 10 x M16, 35 x M12 cable grip www.wago.com/850-828

**Nr. articol: 850-828/002-000**

IP65 enclosure; Aluminium (RAL 7035); WxHxD (480x100x160 mm); 4 x M20, 10 x M16, 35 x M12 cable grip www.wago.com/850-828/002-000

**Nr. articol: 850-834**

IP65 enclosure; Polyester (RAL 7032); WxHxD (164x100x164 mm); 9 x M12, 4 x M20 www.wago.com/850-834

**Nr. articol: 850-835**

IP65 enclosure; Polyester (RAL 7032); WxHxD (244x100x164 mm); 4 x M20, 4 x M16, 14 x M12 cable grip www.wago.com/850-835

**Nr. articol: 850-836**

IP65 enclosure; Polyester (RAL 7032); WxHxD (324x100x164 mm); 4 x M20, 8 x M16, 17 x M12 cable grip www.wago.com/850-836

Descărcări

Documentation

Manual

8-channel, 24VDC, 3.0ms 1-conductor connection; high-side switching	V 1.3.0	pdf 2,0 MB	Descărcare
--	---------	---------------	------------

Additional Information

Disposal; Electrical and electronic equipment, Packaging	V 1.0.0	pdf 265,8 kB	Descărcare
--	---------	-----------------	------------

System Description

Overview on WAGO-I/O-SYSTEM 750 approvals		pdf 780,2 kB	Descărcare
Use in Hazardous Environments Term definition, marking and installation regulations	V 1.0.0	pdf 1,0 MB	Descărcare
750/753 Series I/O-System – General Product Information		pdf 1,7 MB	Descărcare
Design Notes Basic conditions and recommendations for higher operational safety	V 2.0.0	pdf 1,5 MB	Descărcare

Supus modificărilor.

WAGO Kontakttechnik GmbH & Co. KG
/Representative Office Romania
Sos. Pipera-Tunari nr. 1/1
building 1, 2nd floor | 077190 Voluntari, Ilfov
Tel.: +40-(0)31 421 85 68 | Email: info-RO@wago.com

Aveți întrebări despre produsele noastre?
Vă stăm la dispoziție pentru preluarea apelului la +40 (0) 31 421 85 68.



CAD/CAE-Data

CAD data

2D/3D Models 750-430	URL	Descărcare
----------------------	-----	------------

CAE data

EPLAN Data Portal 750-430		Descărcare
---------------------------	--	------------

WSCAD Universe 750-430		Descărcare
------------------------	--	------------

Device Files

Device Driver

WAGO USB Service Kabel Treiber / Serie 750 und 857	6.5.3.0 Sep 10, 2014	zip 4,8 MB	Descărcare
--	-------------------------	---------------	------------

Installation Notes

Familie de produse

750/753 Series – I/O System
[Afișare globală produse din familie.](#)

Supus modificărilor.

WAGO Kontakttechnik GmbH & Co. KG
/Representative Office Romania
Sos. Pipera-Tunari nr. 1/1
building 1, 2nd floor | 077190 Voluntari, Ilfov
Tel.: +40-(0)31 421 85 68 | Email: info-RO@wago.com

Aveți întrebări despre produsele noastre?
Vă stăm la dispoziție pentru preluarea apelului la +40 (0) 31 421 85 68.